

Duct pressure control -
static transducer

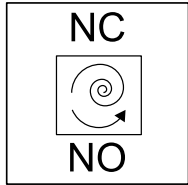

Selectable safe position

Control component

XF4



Control component with spring return actuator for VAV terminal units for duct pressure control

Compact device for use with VAV terminal units

- Controller and static differential pressure transducer for duct pressure in one casing
- Separate actuator with spring return for adjustable safe position
- Duct pressure control in ventilation and air conditioning systems up to 550 Pa, e.g. pressure control in branch ducts
- Suitable for clean and contaminated air
- Constant value control P_{\min} or variable control $P_{\min} - P_{\max}$
- Operating parameters P_{\min} and P_{\max} are set in the factory and saved in the controller
- Activation of override controls via external switch contacts
- Change of operating parameters using adjustment devices
- Service access for manual adjustment devices and PC configuration software

| | | | |
|---------------------|---|-----------------|----|
| General information | 2 | Variants | 6 |
| Function | 3 | Technical data | 7 |
| Specification text | 4 | Product details | 12 |
| Order code | 5 | Nomenclature | 15 |

General information

Application

- All-in-one control devices for duct pressure control
- Static differential pressure transducer and control electronics combined in one casing
- Separate actuator with spring return
- Integration in central building management system or stand-alone operation
- Variable duct pressure control through setting of setpoint values via analogue signal generated by the central building management system
- Constant value control for constant duct pressure without additional signalling thanks to parameterised operating value
- Override controls for the activation of shut-off, OPEN position, control stop possible via switch contacts or relay
- Duct pressure actual value is available as linear voltage signal

Control strategy

- Duct pressure fluctuations are compensated
- To prevent the control from becoming unstable, a dead band is allowed within which the damper blade does not move.
- P_{min} : selected operating value of minimum duct pressure or constant value
- P_{max} : selected operating value of maximum duct pressure
- Operating parameters are specified via the order code and set in the factory

Operating modes

Variable operation (V)

- Setpoint value setting via analogue interface
- Signal voltage range corresponds to P_{min} to P_{max}

Constant value mode (F)

- A setpoint value signal is not required
- Setpoint value corresponds to P_{min}

Interface

Analogue interface with adjustable signal voltage range

- Analogue signal for pressure setpoint value
- Analogue signal for pressure actual value

Signal voltage range

- 0 – 10 V DC
- 2 – 10 V DC

Operating parameters

- Observe the variable duct pressure range from 25 – 550 Pa
- Reference point for the output signal: nominal pressure 600 Pa

Parts and characteristics

- Transducer for static pressure measurements
- Overload protection
- Terminal connections for power and signalling
- Socket for the actuator
- Terminals with cover
- Service interface
- Manual actuator adjustment with crank handle
- Spring-winding mechanism can be locked with crank handle
- Spring-winding mechanism can be unlocked with crank handle

Note:

Differential pressure connections on the outside of the control unit are not accessible with this attachment depending on the variant, e.g. acoustic cladding.

Construction

GUAC-PM6 with spring return actuator 341C-024-05-V/ST06 for: ▪ TVR, TZ-Silenzio, TA-Silenzio, TVZ, TVA, ▪ TVRK up to NW 250
 GUAC-PM6 with spring return actuator 361C-024-20-V/ST06 for: ▪ TVJ ▪ TVT up to dimensions of 1000 x 600 ▪ TVRK from NW 315

Commissioning

- Due to the duct pressures set in the factory, always ensure that the control units are only installed in the specified locations
- Install the control unit and wire the control component
- Install the duct pressure tap and connect it to the control component via tubing
- The controller is then ready for use
- Operating parameters can be adjusted by the customer with an adjustment device, controller potentiometer including display or PC software.

Useful additions

- Adjustment device type GUIV2-A (order code AT-VAV-G)

Function

A static differential pressure transducer converts the duct pressure into a voltage signal. The differential pressure actual value is available as a voltage signal. The factory setting is such that 10 V DC always corresponds to the nominal differential pressure ($\Delta_{p, \text{nom}}$). The differential pressure setpoint value is either a constant value or it comes from a setpoint adjuster or from switch contacts. The controller compares the differential pressure

setpoint value to the actual value and controls the actuator accordingly if there is a difference. Differential pressure parameters and signal voltage range are stored in the control component. Customers can easily make changes using an adjustment device or a notebook with service tool. If the supply voltage is interrupted or a wire breaks, the spring return actuator moves to the safe position OPEN (NO) or CLOSED (NC) as specified in the order code.

Principle of operation for type 227P-024-15-DS6

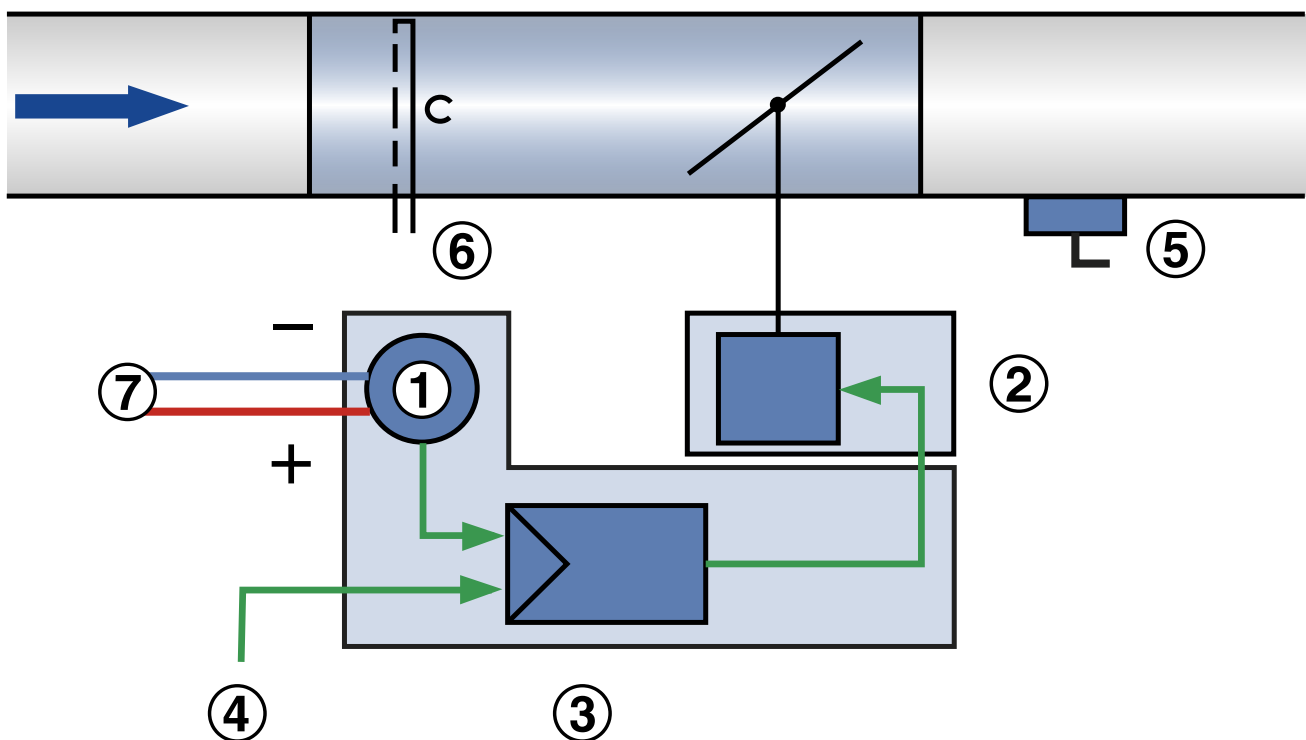

- ① Differential pressure transducer
- ② Actuator
- ③ Differential pressure controller
- ④ Setpoint value signal or constant value
- ⑤ Duct pressure tapping point
- ⑥ Differential pressure sensor of the VAV terminal unit (unused, depending on type and variant possibly not accessible or not

available)

- ⑦ Differential pressure connection at the transducer of the control component, depending on the installation situation (supply air/extract air):
 - One connection side for duct pressure measurement - see ⑤
 - Use other connection side for pressure-stable reference measuring point

Specification text

This specification text describes the general properties of the product.

Category

- Universal controller for duct pressure with safe position

Application

- Control of a constant or variable duct pressure setpoint
- Electronic controller for signalling a reference value and for tapping an actual value signal
- The actual value signal is based on the nominal pressure such that commissioning and subsequent adjustment are simplified
- Stand-alone operation or integration in central building management system

Pressure range

- Static transducer for duct pressure control in ventilation and air conditioning systems
- Control range 25 – 550 Pa

Actuator

- Spring return actuator for defined safe position of the damper blade in case of power failure
- Run time max. 150 s for 90°; run time of spring return < 20 s for 90°

Installation orientation

- Not critical

Connection

- Connection terminals

Supply voltage

- 24V AC/DC

Interface/Signalling

- Analogue signal 0 – 10 V DC or 2 – 10 V DC

Interface information

- Analogue: Duct pressure setpoint and actual values

Special functions

- Display for volume flow actual value and parameter setting
- Activation P_{\min} , P_{\max} , Closed, Open, Control Stop by means of external switch contacts/circuitry

Parameter setting

- Operating values P_{\min} , P_{\max} factory set
- Signal characteristic factory set
- Subsequent adjustment directly via control elements and display on the controller or by means of optional tools: adjustment device, PC software (cable connection in each case)

Order code

TVR – D / 200 / D2 / XF4 / PDS / V 0 / Pmin – Pmax Pa / NC
 | | | | | | | | | | |
 1 2 5 6 7 8 9 10 11 12

1 Type

TVR VAV terminal unit

2 Acoustic cladding

No entry required: none

D With acoustic cladding

3 Material

Galvanised sheet steel (Standard construction)

P1 Powder-coated RAL 7001, silver grey

A2 Stainless steel construction

5 Nominal size [mm]

100, 125, 160, 200, 250

6 Accessories

No entry required: none

D2 Double lip seal both sides

G2 Matching flanges both sides

7 Attachments (control component)

XF4 Universal pressure controller, Static transducer

8 Equipment function/installation location

PDS Duct pressure control, supply air

PDE Duct pressure control, extract air

9 Operating mode

F Constant value (a setpoint value)

V Variable (setpoint value range)

10 Signal voltage range

0 0 – 10 V DC

2 2 – 10 V DC

11 Operating values for factory setting

Duct pressure in Pa

P_{const} (only with operating mode F)

P_{vmin} (only with operating mode V)

P_{vmax} (only with operating mode V)

12 Damper blade position

NO Power off to OPEN

NC Power off to CLOSE

Order example: TVR/100/D2/XF4/PDS/V0/300-500 Pa/NO

| | |
|--|--|
| Acoustic cladding | Without |
| Material | Galvanised sheet steel |
| Nominal size | 100 mm |
| Accessories | Double lip seal both sides |
| Attachment | Universal controller for duct pressure, spring return actuator |
| Equipment function/installation location | Duct pressure control, supply air |
| Operating mode | Variable operation – signal voltage range 0 – 10 V DC |
| Operating value | 300 – 500 Pa |
| Damper blade position | NO, Power off to OPEN |

Order example: TVJ-D/600x300/XF4/PDE/F2/450 Pa/NC

| | |
|--|--|
| Acoustic cladding | With |
| Material | Galvanised sheet steel |
| Dimensions | 600 x 300 |
| Accessories | None |
| Attachment | Universal controller for duct pressure, spring return actuator |
| Equipment function/installation location | Duct pressure control, extract air |
| Operating mode | Constant value mode, signal voltage range 2 – 10 V DC |
| Operating value | 450 Pa |
| Damper blade position | NC, Normally CLOSED |

Variants

Universal controller XF4, type GUAC-PM6

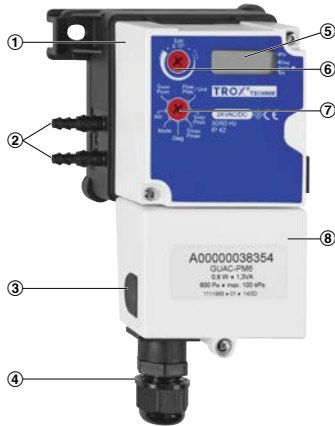

- ① Universal controller
- ② Differential pressure connections (+/-)
- ③ Alternative cable access
- ④ Cable gland for power supply cable
- ⑤ Display
- ⑥ Potentiometer
- ⑦ Menu
- ⑧ Connections behind removable cover

Universal controller XF4, type GUAC-PM6 (terminal cover opened)

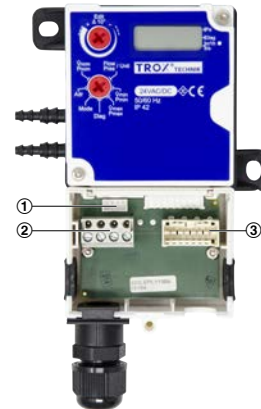

- ① Service connector
- ② Connections for power supply and signalling
- ③ Actuator connection

Actuator with spring return 361C-024-20-V/ST06



- ① Terminal block (drive shaft)
- ② Connecting cable
- ③ Casing actuator
- ④ Plug connection controller
- ⑤ Screws

Actuator with spring return 341C-024-05-V/ST06



- ① Terminal block (drive shaft)
- ② Connecting cable
- ③ Casing actuator
- ④ Plug connection controller
- ⑤ Screws

Technical data

Compact controllers for VAV terminal units

| - | Controller | | Spring return actuator | | - |
|-------------------|--------------|----------|------------------------|--------------------|--------------------|
| Order code detail | Part number | Type | Part number | Type | VAV terminal units |
| XF4 | A00000038354 | GUAC-PM6 | A00000038357 | 341C-024-05-V/ST06 | ① |
| XF4 | A00000038354 | GUAC-PM6 | A00000038355 | 361C-024-20-V/ST06 | ② |

① TVR, TZ-Silenzio, TA-Silenzio, TVZ, TVA, TVRK up to NW 250

② TVJ, TVT up to dimensions 1000 x 500, TVRK from NW 315

Differential pressure controller GUAC-PM6

Differential pressure controller GUAC-PM6

| | |
|---|--|
| Supply voltage (AC) | 24 V AC \pm 20%, 50/60 Hz |
| Supply voltage (DC) | 24 V DC \pm 20 % |
| Power rating (AC) | 5 VA max. |
| Power rating (DC) | Max. 2.5 W plus actuator used * |
| Nominal pressure range | 0 – 600 Pa plus actuator used * |
| Pressure control range | 25 – 550 Pa |
| Torque | 15 Nm |
| Input for setpoint value signal or override control | 0 – 10 V DC, Ra > 100 k Ω or 2 – 10 V DC, Ra > 50 k Ω ** |
| Actual value signal output | 0 – 10 V DC or 2 – 10 V DC, 0.5 mA max. |
| IEC protection class | III (protective extra-low voltage) |
| Protection level | IP 42 |
| EC conformity | EMC to 2014/30/EU |
| Weight | 0.570 kg |

* When dimensioning the transformers and the supply cable for the universal controller, the power consumption of the associated actuator must be taken into account.

** Input can be connected to supply voltage as part of override control.

Actuator with spring return 341C-024-05-V/ST06

Actuator with spring return 341C-024-05-V/ST06

| | |
|--|------------------------------------|
| Supply voltage | from the controller |
| Power consumption for motor (movement) | 5.0 W |
| Standby power consumption (end position) | 2.0 W |
| Rating | 7.5 VA |
| Torque | 5 Nm |
| Run time for 90° | 100 s |
| Spring return time | < 20 s |
| Setpoint value signal input | from the controller |
| IEC protection class | III (protective extra-low voltage) |
| Protection level | IP 54 (cable entry at the bottom) |
| EC conformity | EMC to 2014/30/EU |
| Weight | 1.3 kg |

Actuator with spring return 361C-024-20-V/ST06

Actuator with spring return 361C-024-20V/ST06

| | |
|--|------------------------------------|
| Supply voltage | from the controller |
| Power consumption for motor (movement) | 8.0 W |
| Standby power consumption (end position) | 2.0 W |
| Rating | 11.5 VA |
| Torque | 20 Nm |
| Run time for 90° | 150 s |
| Spring return time | < 20 s |
| Setpoint value signal input | from the controller |
| IEC protection class | III (protective extra-low voltage) |
| Protection level | IP 54 |
| EC conformity | EMC to 2014/30/EU |
| Weight | 1.6 kg |

XF4, Display

Note: Adr without function

Range of display functions
Display functions

- Duct pressure actual value (unit Pa)
- Display via 3-character display with positional notation (vertical line is used as thousands separator)
- Status and error display for various operating states, including display of activated override control, display of diagnostic function
- Display of the firmware version

Setting options

- Work areas P_{min} , P_{max}
- Signal voltage range 0 – 10 V or 2 – 10 V DC

Diagnostic function

- Activation of override controls OPEN, CLOSED, q_{min} , P_{max} , motor stop

Commissioning

- On-site adjusting is not required
- Due to the duct pressures set in the factory, always ensure that the control units are only installed in the specified locations
- Install control unit in the duct section to be controlled
- Set up pressure tap for duct pressure
 - For supply air:
 - Connect differential pressure connection "+" of the controller to the duct to be regulated
 - Leave differential pressure connection "-" of the controller open
 - For extract air:
 - Leave differential pressure connection "+" of the controller open
 - Connect differential pressure connection "-" of the controller to the duct to be regulated
- The connection for the pressure tapping point on the duct must always be made on the side facing away from the fan
- Note duct pressure control ranges as per technical data
- Establish electrical wiring connection
- The controller is then ready for use

Product details

Analogue interface 0 – 10 V or 2 – 10 V DC (operating mode V, F)

The analogue interface can be adjusted for the signal voltage range 0 – 10 V DC or 2 – 10 V DC. The assignment of the duct pressure setpoint value or actual value for voltage signals is shown in the characteristic curves.

- The set signal voltage range always applies equally for setpoint value and actual value signals.
- The signal voltage range is pre-set in the factory according to the order code entries.
- Signal voltage range can be adjusted on site in the adjustment menu on the display, via adjustment device or PC software.

Setpoint value setting

Variable operation

- In the operating mode V (variable operation), the setpoint value is specified with an analogue signal on terminal Y.
- The selected signal voltage range 0 – 10 V or 2 – 10 V DC is assigned to the pressure range $P_{\min} - P_{\max}$.
- Operating values $P_{\min} - P_{\max}$ pre-set in the factory according to the order code entries.
- Subsequent adjustment of P_{\min} or P_{\max} can be adjusted in the adjustment menu on the display or with adjustment device or PC software.

Constant value mode

- In operating mode F (constant value mode), an analogue signal on terminal Y is not required.
- The set duct pressure constant value P_{\min} is used.
- Operating value P_{\min} is pre-set in the factory according to the order code entry.
- Subsequent adjustment of P_{\min} can be adjusted in the adjustment menu on the display or with adjustment device or PC software.

Actual value as feedback for monitoring or tracking control

- The actual duct pressure measured by the controller can be tapped as a voltage signal at terminal U.
- The selected signal voltage range 0 – 10 V DC or 2 – 10 V DC is converted to the pressure range 0 – P_{Nominal} .
- Reference point $P_{\text{Nominal}} = 600 \text{ Pa}$

Override control

For special operating situations, the duct pressure controller can be put in a special operating mode (override control). The following modes are possible: control P_{\min} , control P_{\max} , damper blade in the OPEN position, damper blade CLOSED.

Under certain conditions the control can also be suspended (control stop).

Override control via signal input Y

- With appropriate wiring on the signal input Y, the override controls can be activated according to the connection diagrams via wiring with external switch contacts/relays.
- OPEN and CLOSED are only available if the controller is supplied with alternating current (AC).
- In the signal voltage range 2 – 10 V, the differential pressure control can be suspended (stop) by connecting input Y to GND.

Override control CLOSED via control signal Y

- With signal voltage range 0 – 10 V DC: CLOSED is activated when $P_{\min} = 0$ is set and the control signal is $Y < 0.5 \text{ V DC}$.
- With signal voltage range 2 – 10 V DC: CLOSED is activated when control signal is $Y < 0.8 \text{ V DC}$ (0.8 V = factory setting).
- The specified switching point of 0.8 V corresponds here to the factory default setting.

Override controls for diagnostic purposes

- For test purposes, the override control can also be activated via the integral display, adjustment device or PC software.

Prioritisation of various setting options

- High priority: settings via the display, adjustment device or PC software
- Low priority: settings via wiring on the Y signal input of the controller

Spring return actuator

- The spring return function in case of power failure is prepared at the factory according to the order option. NC = damper CLOSED, NO = damper OPEN. On site, this function cannot be changed by parameterisation via service tools.

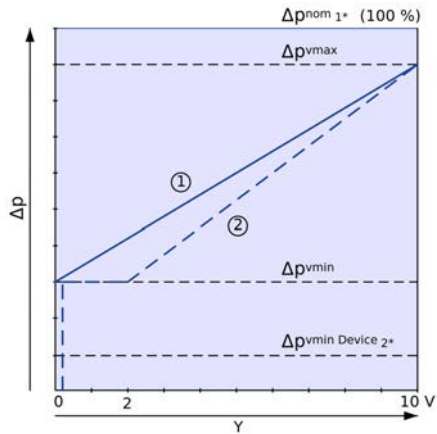
Characteristic of the setpoint value signal

- ① Signal voltage range 0 – 10 V
- ② Signal voltage range 2 – 10 V
- 1* = Δp_{nom} Nominal pressure difference
- 2* = $\Delta p_{min \text{ device}}$ Minimum adjustable pressure difference

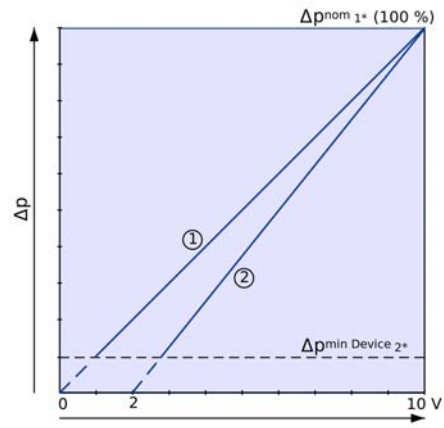
Characteristic of the actual value signal

- ① Signal voltage range 0 – 10 V
- ② Signal voltage range 2 – 10 V
- 1* = Δp_{nom} Nominal pressure difference
- 2* = $\Delta p_{min \text{ Device}}$ Minimum adjustable pressure difference

Calculation of differential pressure setpoint value for 0 – 10 V

$$\Delta p_{set} = \frac{w}{10} (\Delta p_{max} - \Delta p_{min}) + \Delta p_{min}$$

Calculation of differential pressure actual value for 0 – 10 V

$$\Delta p_{act} = \frac{U5}{10} \times \Delta p_{nom}$$

Calculation of differential pressure setpoint value for 2 – 10 V

$$\Delta p_{set} = \frac{w - 2}{8} (\Delta p_{max} - \Delta p_{min}) + \Delta p_{min}$$

Calculation of differential pressure actual value for 2 – 10 V

$$\Delta p_{act} = \frac{U5 - 2}{8} \times \Delta p_{nom}$$

View of the pluggable terminal strip of the GUAC-PM6

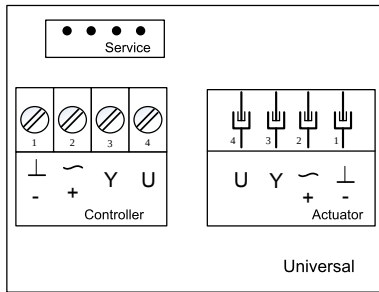

Service: Connection socket for the adjustment device

Actuator: Connection socket for the actuator

Controller: Power supply and signalling

Controller:

1 \perp , - = Ground, neutral

2 \sim , + = Supply voltage 24 V

3 Y = setpoint value signal Y and override controls

4 U/pp = actual value signal U or adjustment device or interface adapter GUIV-S for PC software

Variable duct pressure control and override control

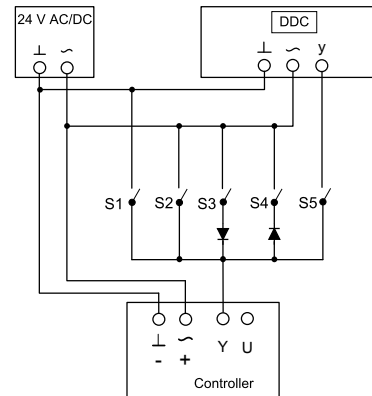

S1: (0 – 10 V)

- If $P_{\min} = 0$ set, then damper CLOSED
- If $P_{\min} > 0$ is set, then P_{\min}

S1: (2 – 10 V)

- Control stop

S2: Setpoint value setting P_{\max}

S3: Damper blade OPEN (only with supply voltage 24 V AC)

S4: Damper blade CLOSED (only with supply voltage 24 V AC)

S5: Setpoint value setting - variable duct pressure via control signal

All switches open (input open): Constant value mode with setpoint value setting P_{\min}

DDC = Setpoint value setting

When combining several override controls, the switches must be interlocked to prevent short-circuits.

Diode: e.g. 1N 4007

Nomenclature

Δ_{pNom} [Pa]

Nominal pressure (100 %): Maximum differential pressure that can be detected by the pressure transducer and converted into an electrical signal. Please note that the adjustable differential pressure range is only a range of the nominal pressure and cannot be fully utilised (see technical data). Δ_{pNom} is the reference value for defining Δ_{pmin} and Δ_{pmax} .

Δ_{pmax} [Pa]

Upper limit of the operating range of the duct pressure controller adjustable by the customer (note usable control range see technical data). For analogue control of duct pressure controllers (typically used), the maximum value of the setpoint signal (10 V) is assigned the set maximum value (Δ_{pmax}) (see characteristic).

Δ_{pmin} [Pa]

Customer-adjustable lower limit of the operating range of the duct pressure controller: Δ_{pmin} should be set to less than or equal to Δ_{pmax} . Δ_{pmin} should not be set lower than the lower control range, otherwise the control is unstable. With analogue control, the minimum value of the setpoint signal (0 or 2 V) is assigned the set minimum value Δ_{pmin} (see characteristic).

Δ_p [Pa]

Differential pressure

Duct pressure controller

Consists of a basic unit and an attached control component for duct pressure control

Basic unit (for duct pressure controller)

Control unit without attached control component. The main components are the casing and the damper blade to control the differential pressure in the relevant section of the air duct.

Important distinguishing features:

Geometry or unit shape, material and types of connection, acoustic characteristics (e.g. acoustic cladding option or integral silencers).

For manufacturing reasons, the basic unit is based on the basic units for volume flow control and is therefore also referred to as a VAV terminal unit. Sensor elements of the VAV terminal unit are therefore usually present, but are not accessible in all construction variants, e.g. acoustic cladding.

The pressure measurement point is typically placed in the air duct downstream of the terminal unit.

Control component (for duct pressure controller)

Electronic unit(s) mounted on the basic unit to control the pressure in an air duct section (e.g. branch) by adjusting the control damper position.

The electronic unit essentially consists of a controller with differential pressure transducer (integral or external) and an actuator, which is an integral part of compact controllers and separately supplied for universal controllers, e.g. to define additional functions such as a safe position.

Important distinguishing features:

- Transducers: Measuring and control range
- Actuator variants VARYCONTROL universal controller:
 - Standard actuator, slow-running
 - Spring return actuator for damper blade safety function
- Actuator variants TROX UNIVERSAL:
 - Standard actuator, slow-running
 - Spring return actuator for damper blade safety function
 - Fast-running actuator
- Interface technology:
 - Analogue interface or digital bus interface for the capturing and transmission of signals and information only with TROX UNIVERSAL: various expansion modules can be used, e.g. for simultaneous volume flow rate measurement.