



Control components

XM0-J6

Bus interface Modbus RTU



X-AIRCONTROL Modbus zone module

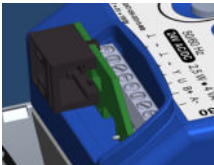

RJ12 socket

Control component with dynamic transducer and Modbus RTU interface for X-AIRCONTROL

Compact unit for VAV terminal unit TVE and TVE-Q

- Controller, dynamic differential pressure transducer and actuator in one casing
- Use in ventilation and air conditioning systems, only with clean air
- Simple RJ12 connection socket for supply voltage and network
- Compatible with the X-AIRCONTROL zone module Modbus
- Volume flow rates q_{vmin} and q_{vmax} are pre-set in the factory and saved in the controller as variable parameters
- High data transparency via standardised bus communication Modbus RTU, RS485
- Setpoint value settings, override controls, parameter adjustment via Modbus register
- Integrated display for indication volume flow rate and operating status, and setting of operating parameters
- Service access for manual adjustment devices and PC configuration software

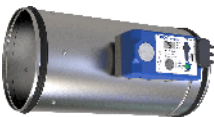

Control component for type TVE



Control component for type TVE

General information	2	Variants	6
Function	3	Technical data	7
Specification text	4	Product details	17
Order code	5	Explanation	20

General information

Application

- All-in-one control devices for VAV terminal units types TVE and TVE-Q
 - Dynamic differential pressure transducer, electronic controller, and actuator are combined in one casing
 - Dynamic transducer for clean air in ventilation and air conditioning systems
 - Standard filtration in comfort air-conditioning systems allows the controller to be used in the supply air without additional dust protection measures
 - Various control options based on setpoint value default setting
 - Suitable for X-AIRCONTROL room control, Modbus zone module
 - By specifying setpoints via the communication interface, the control circuits for e.g. temperature, humidity, air quality control the variable air volume flow
 - Simple connection for supply voltage and network with one shared RJ12 connection socket
 - Override controls for activating q_{vmin} , q_{vmax} , shut-off, OPEN are possible using the Modbus register
 - The actual volume flow rate value is available as a network data point
 - The damper blade position is available as a network data point
- If air is contaminated with dust, lint, sticky, moist or slightly aggressive particles:
- Use the XS0-J6 control module (instead of the XM0-J6 compact controller described here)

Control strategy

- The volume flow controller works independently of the duct pressure
- Differential pressure fluctuations do not result in permanent volume flow rate changes
- To prevent the control from becoming unstable, a dead band is allowed within which the damper blade does not move
- Flow rate range is set in the controller at the factory (q_{vmin} : minimum volume flow rate, q_{vmax} : maximum volume flow rate)
- Operating parameters are specified via the order code and set in the factory

Operating modes

- Modbus (M): setpoint value default via X-AIRCONTROL

Communication interface

- Modbus RTU, RS 485
- Data point list see Modbus register list

Parts and characteristics

- Transducer based on dynamic measuring principle. It can only be used with clean air, as a partial volume flow is passed through the transducer
- Overload proof actuator
- RJ12 connection socket with cover
- Display and control elements for easy menu navigation
- Menu navigation allows for adjusting operating parameters and communication interface
- Service interface

Construction

- TR0VM-024T-05I-DD15-MB with RJ12 connection socket
- Can only be used for type TVE and TVE-Q

Commissioning

- As the volume flow rates are factory set, the terminal units have to be installed at the specified locations
- Network integration requires commissioning steps
- Operating parameters can be adjusted by others (using the display and control elements, an adjustment device or the Modbus register)

Useful additions

- Adjustment device type GUIV3-M (order code AT-VAV-G3)
- Room control X-AIRCONTROL with zone module Modbus type X-AIR-ZMO-MOD

Function

Air terminal units control the volume flow in a closed loop, which means: measurement – comparison – adjustment.
The volume flow rate is obtained by measuring a differential pressure. This is effected via a differential pressure sensor. The integrated differential pressure transducer converts the differential pressure into a voltage signal. The actual volume flow value is available as a data point. Du to the factory adjustment, 100% always equals the nominal volume flow rate (q_{vNom}).

The volume flow setpoint value is specified by a higher-level controller (e.g. room temperature controller, air quality controller, central BMS). Variable volume flow control can be set between q_{vmin} and q_{vmax} . It is possible to override the room temperature control by forced switching, e.g. for a shut-off
The controller compares the volume flow setpoint with the current actual value and adjusts the internal actuator according to the control deviation.

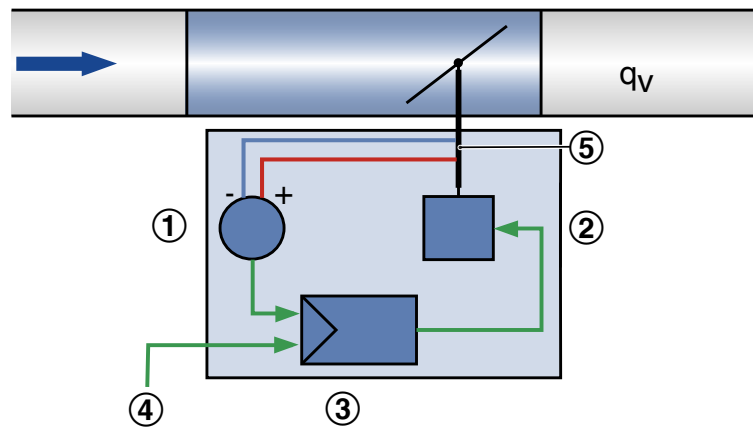

- ① Differential pressure transducer
- ② Actuator
- ③ Volume flow controller
- ④ Setpoint via Modbus or analogue signal
- ⑤ Shaft with effective pressure channel

Specification text

This specification text describes the general properties of the product.

Category

- Compact controller for volume flow rate
- Control of a constant or variable volume flow rate setpoint
- Electronic controller for connecting a reference variable and recording an actual value for integration into X-AIRCONTROL
- The actual value relates to the nominal volume flow rate so that commissioning and subsequent adjustment are simplified

Application

- Dynamic transmitter for clean air in ventilation and air conditioning systems

Supply voltage

- 24 V AC/DC

Actuator

- Integral; slow-running (running time 100 s for 90°)

Installation orientation

- Not critical

Interface/signalling

- Modbus RTU (RS-485)

Connection

- RJ12 connection socket for easy connection to X-AIRCONTROL, with rubber cap cover

- Suitable for X-AIRCONTROL zone module X-AIR-ZMO-MOD

Interface information

- Modbus: includes writing and reading of volumetric flow setpoint and actual value signal, damper position, override control

Special functions

- Clearly visible external indicator light for indicating the functions: Set, not set, and power failure
- Display for actual values, parameter setting and for test functions
- Activation q_{vmin} , q_{vmax} , closed, open by X-AIRCONTROL

Parameter setting

- Specific parameters for VAV terminal unit are factory-set
- Operating values: q_{vmin} , q_{vmax} are factory-set
- Subsequent adjustment via display and operating element directly on the unit or with optional tools: Setting device, PC software (each wired), in Modbus mode also via Modbus register access

Factory condition

- Electronic controller factory-mounted on the terminal unit
- Factory set parameters
- Functional test under air; certified with sticker

Order code

TVE – D / 200 / D2 / XM0-J6 / M / qvmin – qvmax m³/h
 1 | 2 | 5 | 6 | 7 | 8 | 9 | 10

1 Type

TVE VAV terminal unit

2 Acoustic cladding

No entry: none

D With acoustic cladding

3 Material

Galvanised sheet steel (standard construction)

P1 Powder-coated RAL 7001, silver grey

A2 Stainless steel construction

5 Nominal size [mm]

100, 125, 160, 200, 250, 315, 400

6 Accessories

No entry: none

Order example: TVE/100/D2/XM0-J6/M/20-350 m³/h

Acoustic cladding

Material

Nominal size

Accessories

Attachment (control components)

Operating mode

Volume flow rate

D2 Double lip seal both ends

G2 Matching flanges for both ends

7 Attachments (control components)

XM0-J6 Compact controller with dynamic transducer, Modbus RTU, display, RJ12 socket

8 Operating mode

M Modbus RTU

9 Operating values for factory setting

Volume flow rates in m³/h or l/s

q_{vmin}

q_{vmax}

10 Volume flow rate unit

m³/h

l/s

without

galvanised sheet steel

100 mm

Double lip seal both ends

Compact controller volume flow, dynamic transmitter, Interface Modbus RTU, display, RJ12 connection socket (for X-AIRCONTROL)

Modbus RTU

20 – 350 m³/h

Variants

Compact controller XM0-J6 for TVE and TVE-Q

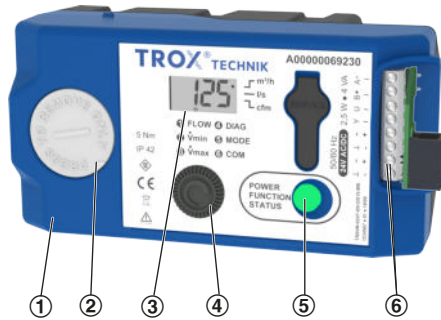

Compact controller XM0-J6 for TVE and TVE-Q (with attached terminal cover)

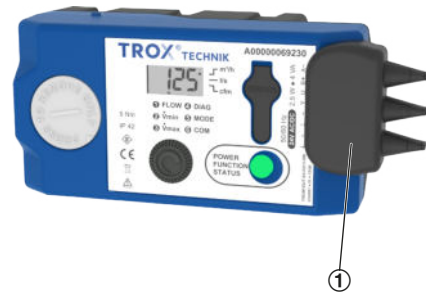

- ① Compact controller
- ② Damper blade position indicator and release button
- ③ Display
- ④ Rotary selector switch - Selection of options/setting values
- ⑤ LED button - Selection of menu entry
- ⑥ Connection socket RJ12

- ① Cover for connection socket (part of the supply package)

Technical data

Compact controllers for VAV terminal units

Part number	Type of installation component	VAV terminal units
A00000069230	TR0VM-024T-05I-DD15-MB	TVE, TVE-Q



Compact controller TR0VM-024T-05I-DD15-MB with RJ12 connection socket

Type of measurement/installation orientation	Dynamic measurements, any installation orientation
Supply voltage (AC)	24 V AC, $\pm 20\%$, 50/60 Hz
Supply voltage (DC)	24 V DC $\pm 20\%$
Power rating (AC)	NW 100 – 160: maximum 4 VA NW 200 – 400: maximum 7 VA TVE-Q up to height 200: maximum 4 VA TVE-Q from height 300: maximum 7 VA
Power rating (DC)	NW 100 – 160: maximum 2.5 W NW 200 – 400: maximum 4 W TVE-Q up to height 200: maximum 2.5 W TVE-Q from height 300: maximum 4 W
Power consumption (when running/when idle)	1 W
Run time for 90°	100 s
IEC protection class	III (Protective extra-low voltage)
Protection level	IP 42 (with attached terminal cover)
EC conformity	EMC to 2014/30/EU
Bus connection	Modbus RTU, RS485
Number of nodes	128
Adjustable communication parameters	1200 – 115,200 Bd Start bit: 1 Data bits: 8 Stop bits: 1 or 2 Parity: None, Even, Odd
Setpoint / actual value interface (Modbus)	Via X-AIRCONTROL/Modbus register list
Cable termination	externally required

Interface configuration of the control component

The communication interface for the control component is pre-set to Modbus at the factory for use with the X-AIRCONTROL zone module. Only the Modbus address must be set by the customer, depending on the use in the supply air and extract air. For other applications, data transmission speed and format must be adapted on site according to the network environment.

XM0-J6	Setpoint value default setting via:	Actual values via:	corresponds to order key option	Menu configuration (Mode)
Analogue operation *	analogue 0 - 10 V	analogue 0 - 10 V	V or F	CA0
Analogue operation *	analogue 2 - 10 V	analogue 2 - 10 V	V or F	CA2
Modbus operation	Modbus register setpoint	Modbus register actual value or analogue 2 - 10 V	M	CB

* It is not possible to use the analogue interface in combination with the RJ12 connection socket provided with the XM0-J6 variant. Therefore, the configuration register 122 (interface mode) must not be changed on site. To use an analogue interface, type XM0 must be installed.

Communication interface Modbus RTU (operating mode M)

Register	Meaning	Access right	Storage
0	Volume flow setpoint [%] Reference: Vmin – Vmax (qvmin – qvmax) Resolution: 0 – 10000 Volume flow setpoint: 0.00 - 100.00%	R, W	RAM
1	Activation of an override control; 0 = none; 1 = Open; 2 = Close; 3 = Vmin; 4 = Vmax	R, W	RAM
2	Command triggering 0 = none; 1 = adaptation; 2 = test run; 4 = controller reset	R, W	RAM
4	Current damper blade position [%] Resolution: 0 – 10000 Damper blade position: 0.00 – 100.00%	R	RAM
5	Current damper blade position [°] Reference: without decimal places	R	RAM
6	Current actual volume flow [%] Resolution: Vnom Resolution: 0 – 10000 Actual volume flow rate: 0.00 - 100.00%		RAM
7	Actual volume flow rate in volume flow rate unit [m³/h], [l/s], [cfm] according to register 201	R	RAM
8	Voltage at analogue input Y [mV] Note: Connection terminal for analogue input Y not accessible with variant with connection socket	R	RAM
20	Volume flow setpoint in volume flow unit [m³ /h], [l/s], [cfm] acc. to register 201	R, W	RAM



103	Firmware version	R 0.00 – 100.00 %	EEPROM
104	Status information (Bit = 1 active; Bit = 0 inactive) Bit 5 mechanical overload Bit 8 internal activity e.g. test run, adaptation Bit 10 bus timeout monitoring triggered	R	RAM
105	Operating range limitation: Operating parameter Vmin (qvmin) [%] Resolution: Vnom Resolution: 0 – 10000 Vmin: 0.00 – 100.00%	R, W	EEPROM
106	Operating range limitation: Operating parameter Vmax (qvmax) [%] Resolution: Vnom Resolution: 0 – 10000 Vmax: 0.00 – 100.00%	R, W	EEPROM
108	Behaviour on bus failure (bus time-out); 0 = nothing; 1 = closed; 2 = open; 3 = qvmin; 5 = qvmax	R, W	EEPROM
109	Setting bus time-out [s]	R, W	EEPROM
120	Definition of operating range: operating parameters Vmin (qvmin) in volume flow rate unit [m ³ /h], [l/s], [cfm] according to register 201	R, W	EEPROM
121	Definition of operating range: operating parameters Vmax (qvmax) in volume flow rate unit [m ³ /h], [l/s], [cfm] according to register 201	R, W	EEPROM
122	Interface definition (Interface mode) For assignment see separate table	R, W	EEPROM
130 *	Modbus address (device address)	R, W	EEPROM
201	Volume flow rate unit 0 = l/s; 1 = m ³ /h; 6 = cfm	R, W	EEPROM
231	Setting of mode: Bit 0 defines the characteristic of the analogue interface. Bit 0 = 0 characteristic: 0 – 10 V Bit 0 = 1 characteristic: 2 – 10 V Bit 4 defines the actual value signal as actual volume flow rate or damper position. Bit 4 = 0 Actual volume flow rate Bit 4 = 1 Damper blade position All other bits must not be changed.	R, W	EEPROM
233	Nominal flow rate [m ³ /h] (Vnom):	R	EEPROM



	Displays the parameterised nominal volume flow rate		
568	Modbus parameter set communication settings: baud rate, parity, stop bits, assignment see separate table	R, W	EEPROM
569	Modbus communication settings: Modbus Response Time = 10 ms + delay; with delay= 3 ms × register value 0 - 255	R, W	EEPROM
572	Setting of switching threshold for override control CLOSE via control signal for signal voltage range 2 – 10 V: Setting range 0.5 V – 1.8 V Default value 0.8V (register value = 20) Resolution: 1 setting unit = 40mV	R, W	EEPROM

* Factory setting: Modbus address 1

R = register readable

R,W = register readable and writeable

RAM = register value temporary

EEPROM = register value not temporary, but permanently stored (maximum 1 million write operations)

Note:

All registers from register number 100 onwards with storage in the EEPROM are not suitable for cyclic write access, e.g. by the central building management system. Cyclic write operations are only permitted on registers with storage in RAM.

Detailed information on register 122 (communication interface setpoint/actual value - interface mode)

Register value	Signal input	Feedback signal
0	analogue (0) 2 - 10 V	(0)2 – 10 V
1	Modbus via Register 0	(0)2 – 10 V
2	Modbus via Register 0	Register 10
3	analogue (0) 2 - 10 V	Register 10

Note:

For the control components XM0-J6 and XS0-J6, only register value 2 is useful, as analogue input and analogue feedback signal are not available on the RJ12 connection socket.



Detailed information on register 568 (Modbus communication parameters)

Register value	Display setting value	Baud rate	Parity	Stop bits
0	1	1200	None	2
1	2	1200	straight	1
2	3	1200	odd	1
3	4	2400	None	2
4	5	2400	straight	1
5	6	2400	odd	1
6	7	4800	None	2
7	8	4800	straight	1
8	9	4800	odd	1
9	10	9600	None	2
10	11	9600	straight	1
11	12	9600	odd	1
12	13	19200	None	2
13	14	19200	straight	1
14	15	19200	odd	1
15 **	16	38400	None	2
16	17	38400	straight	1
17	18	38400	odd	1
18	19	1200	None	1
19	20	2400	None	1
20	21	4800	None	1
21	22	9600	None	1
22	23	19200	None	1
23	24	38400	None	1
24	25	76800	None	1
25	26	115200	None	1
26	27	76800	None	2
27	28	76800	straight	1
28	29	76800	odd	1
29	30	115200	None	2
30	31	115200	straight	1
31	32	115200	odd	1

** Factory setting: Modbus communication parameters

Commissioning

After installation, wiring and connection of the supply voltage

- Set Modbus communication parameters via the integrated menu, then the air terminal unit is ready for operation
- Setpoint specification via Modbus register from X-AIRCONTROL zone module
- Remove terminal cover of the control component only briefly during wiring

Observe volume flow control ranges

- TVE: 4 - 100 % of q_{vnom}
- TVE-Q: 10 - 100 % of q_{vnom}
- In particular, do not set values below the minimum volume flow of the control unit

Range of display functions**Display functions**

- Actual volume flow rate (unit optionally m^3/h , l/s , cfm)
- 3-character display with place value indication
- Status and error display for various operating states, including display of activated override control and diagnosis function

Parameter settings

- Adjustment option for the unit of the volume flow rate display m^3/h , l/s , cfm
- Adjustment option for the operating range $q_{v\text{min}}$, $q_{v\text{max}}$
- Selection of the interface configuration Modbus or analogue, including signal voltage range 0 - 10 V or 2 - 10 V DC. For the variant with RJ12 connection socket, only the interface configuration Modbus is suitable
- Setting option for Modbus communication settings (address, baud rate, stop bits, parity)

Diagnostic functions

- Activation of a test run
- Activation of override controls Open, Closed, $q_{v\text{min}}$, $q_{v\text{max}}$, motor stop (observe prioritisation)
- Display of the voltage value on the analogue input

Use and description of the display

Pressing the LED button (< 3 s) selects the next menu item (1) - (6). The selected menu item can be changed by pressing the LED push button for more than 3 s. Changing is done with the rotary selector switch. Pressing the LED push button again (< 3 s) confirms the selected value. If no entry is made for ≥ 60 s, the system returns to menu item 1.

Section of the controls

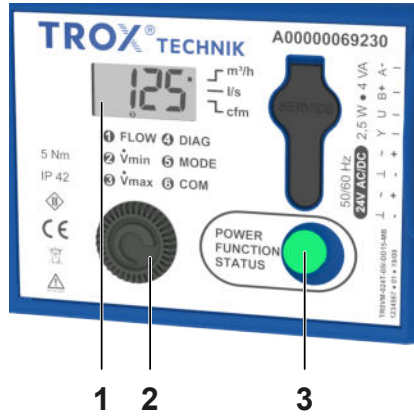

- 1: Display
- 2: Rotary selector switch
- 3: LED push button

Table 1: Description of the menu items

① Flow	Display of actual values or operating states. Setting of the volume flow unit m ³ /h, l/s, cfm.
② Vmin	Setting qvmin
③ Vmax	Setting qvmax
④ DIAG	Display of control signal and feedback signal alternately in [V], Activation of override controls for test and diagnostic purposes: tst = test drive oP = damper open cL = damper closed Lo = q _{vmin} Hi = q _{vmax} St = motor stop oFF = override control off 000 = Display firmware version
⑤ MODE	Selection of the operating mode: CA0 = Setpoint input and actual value return via analogue interface (0 - 10 V) CA2 = Setpoint input and actual value return via analogue interface (2 - 10 V) CB2 = Setpoint input and actual value return via Modbus - optional actual value return via (2 - 10 V)
⑥ COM	Setting the Modbus address: 1 - 247 and the baud rate, parity, stop bits: 1 (b1) - 32 (b32)

Note on MODE setting:

For the control component XM0-J6 or XS0-J6, only the mode setting CB2 is useful, as setpoint input and actual value return as analogue signal are not available on the RJ12 connection socket of these control components.

Description of status LEDs and error messages

LED flashing signal	Status	Display
	no power supply connected	
	Service tool plugged in. On-site network connection deactivated. Forced controls from the service tool have priority	
	Undervoltage detected. Supply voltage outside the tolerance range. Control function not guaranteed	
	TROX service technicians provide information. Incomplete parameterisation was detected during power-on/reset *	
	Drive overload detected (block) *	
	Synchronisation drive after Power Up *	
	Test mode enabled *	
	Overpressure sensor (Overpressure) *	
	Setpoint or forced control position not yet reached (display changes between e.g. Hi = high and actual value) *	
	Forced control position reached (display changes between e.g. Hi = High and actual value) *	
	Offset: Is signalled as long as the drive does not rotate to readjust the setpoint value *	

Notes:

- The signal spans 2 seconds. 1 = LED is illuminated, 0 = LED is not illuminated
- For service tool plugged in (display: Pc) and undervoltage detected (display: Lou), no special flashing signal appears on the LED button. Instead, one of the operating states marked with an asterisk (*) is displayed.

Product details

Modbus operation (order code operation mode M)

For smooth data exchange in the on-site Modbus RTU network, it is necessary to set the communication parameters and the participant address for the Modbus interface.

The interface offers standardised Modbus register access to the available data points via the functions ReadHoldingRegister (3) and WriteSingleRegister (6).

Setpoint value setting

- In operating mode M, the setpoint is only specified by entering the volume flow setpoint [%] in Modbus register 0
- The transferred percentage value refers to the volume flow rate range specified by $q_{vmin} - q_{vmax}$
- Volume flow rate range $q_{vmin} - q_{vmax}$ set at the factory according to the order code details
- Subsequent adjustment of q_{vmin} or q_{vmax} possible in the setting menu on the display, with setting device, Modbus interface or X-AIRCONTROL

Actual value as feedback

- The current volume flow rate value can be retrieved via the display, adjustment device, or X-AIRCONTROL
- In addition to the actual volume flow rate value, further information can be obtained via X-AIRCONTROL

Override control options

For specific operating situations, the volume flow controller can be set to a special operating mode (override control)

Possible modes: Control q_{vmin} , control q_{vmax} , damper blade in the OPEN position or damper blade CLOSED.

- Specifications set via X-AIRCONTROL
- Override control for bus failure monitoring:
- If the communication fails, the controller performs its last stored state (according to its factory setting). Using appropriate software, the factory setting can be changed via Modbus register 108. Any communication resets the time-out of bus failure monitoring

Override controls for diagnosis

Activation via the diagnostic menu on the controller display or via X-AIRCONTROL.

Prioritisation of various override control options

Specifications via service tools are prioritised over Modbus settings.

- Highest priority: Default setting via the service plug (adjustment device, PC software), for testing purposes
- Lowest priority: Default setting via Modbus register 1 or the diagnostics menu on the controller

Note:

Cyclic writing to registers with storage in the EEPROM is not permitted. This applies in particular to basic setting parameters for the working range q_{vmin} (register 105 or 120), q_{vmax} (register 106 or 121), the definition of the interface type (register 122) and all other registers from number 100. See also notes on writeability at the end of the Modbus register description.

Pin assignment RJ12 connection socket

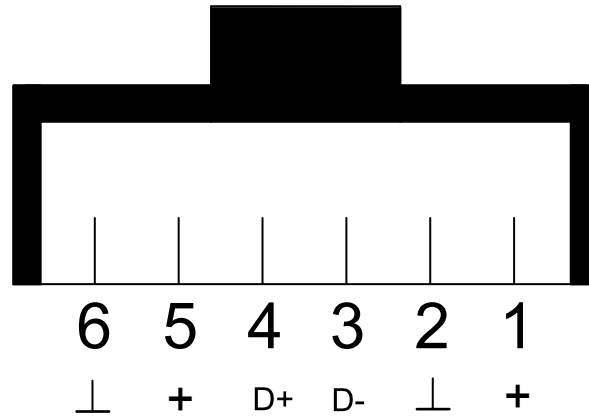

- 1 ⊥, - = Ground, Zero
- 2 ~, + = Supply voltage 24 V
- 3 B+ = Modbus RTU
- 4 A- = Modbus RTU
- 5 ⊥, - = Ground, Zero
- 6 ~, + = Supply voltage 24 V

Modbus RTU connections in conjunction with X-AIRCONTROL

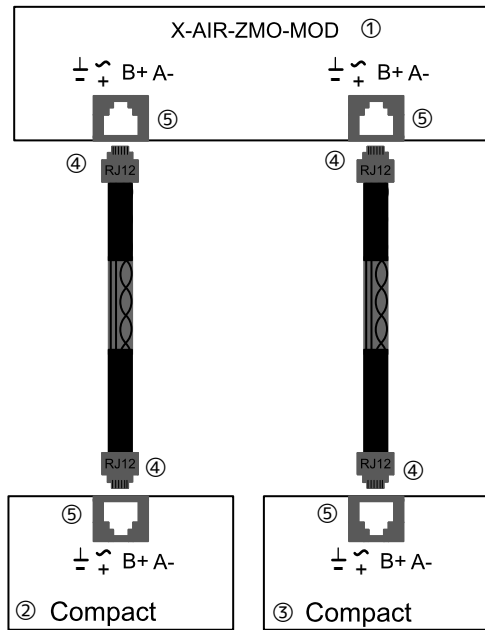

⊥, - = Ground, zero

~, + = 24 V supply voltage

B+ = Modbus RTU

A- = Modbus RTU

① TROX X-AIRCONTROL Modbus RTU zone module for easy system integration

② Compact controller with built-in RJ12 connection socket, e.g. for room supply air

③ Compact controller with built-in RJ12 connection socket, e.g. for room extract air

④ RJ12 connector (plug & play connection)

⑤ RJ12 connection socket for easy plug-in connection (plug-and-play)

Note:

Supply and bus connections are not galvanically isolated

- Voltage supply: Make sure that all devices on the bus have the same GND reference point
- Use bus terminating resistors at the ends of the bus line

Explanation

q_{vNom} [m³/h]; [l/s]; [CFM]

Nominal flow rate (100 %): The value depends on product type, nominal size and control component (attachment). Values are published on the internet and in technical leaflets and defined in the Easy Product Finder design programme. Reference value for calculating percentages (e.g. q_{vmax}). Upper limit of the setting range and maximum volume flow rate setpoint value for the VAV terminal unit.

$q_{vmin Unit}$ [m³/h]; [l/s]; [CFM]

Technical minimum volume flow: The value depends on product type, nominal size and control component (attachment). Values are defined in the Easy Product Finder design programme Lower limit of the setting range and minimum volume flow rate setpoint value for the VAV terminal unit. Setpoint values below $q_{vmin Unit}$ (if q_{vmin} equals zero) may result in unstable control or shut-off.

q_{vmax} [m³/h]; [l/s]; [CFM]

Client-adjustable upper limit of the operating range for the VAV terminal unit: q_{vmax} can be set to less than or equal to q_{vNom} on the terminal unit. In case of analogue control of volume flow controllers (typically used), the maximum value of the setpoint signal (10 V) is assigned to the set maximum value (q_{vmax} , see characteristics).

q_{vmin} [m³/h]; [l/s]; [CFM]

Client-adjustable lower limit of the operating range of the VAV terminal unit: q_{vmin} should be set to less than or equal to q_{vmax} . q_{vmin} must not be set to less than $q_{vmin Unit}$, as the control may become unstable or the damper blade may close. q_{vmin} may equal zero. In case of analogue control of volume flow controllers (typically

used), the minimum value of the setpoint signal (0 or 2 V) is assigned to the set minimum value (q_{vmin} , see characteristics).

q_v [m³/h]; [l/s]; [CFM]

Volume flow rate

Volume flow controller

Consists of a basic unit with an attached control component.

Basic unit

Unit for controlling volume flow rates without an attached control component. The main components include the casing with sensor(s) to measure the differential pressure and the damper blade to restrict the volume flow. The basic unit is also referred to as a VAV terminal unit. Important distinguishing features: Geometry or unit shape, material and connection variants, acoustic characteristics (e.g. optional acoustic cladding or integrated silencers), range of volume flow.

Control component

Electronic unit(s) mounted on the basic unit to control the volume flow rate, or the duct pressure, or the room pressure by adjusting the damper blade position. The electronic unit mainly consists of a controller with differential pressure transducer (integrated or external), and an integrated actuator (Easy and Compact controllers) or external actuator (Universal or LABCONTROL controller). Important distinguishing features: Transducer: dynamic transducer for clean air, or static transducer for polluted air. Actuator: Standard actuator (slow-running), spring return actuator for fail-safe position, or fast-running actuator. Interface technology: analogue interface or digital bus interface for connecting and recording signals and data.